

C64933

INSTALLATION INSTRUCTIONS SHEET

START FROM HERE

- Make sure power is completely off at the fuse box.
- Have your fixture installed by a qualified licensed electrician
- Prepare everything in clear area.
- Wear gloves at all times during this installation.
- Read instructions carefully before you start assembly.
- Keep this instruction sheet for future reference.

Technical Support: 1-844-628-8368

Please Note:

- All Matteo Lighting fixtures come with pre-wired module(s).
- Unless instructed to do so, please do not touch any part of the module(s) as unnecessary contact with the module could cause permanent damage.

THIS LUMINAIRE MUST BE MOUNTED OR SUPPORTED IN A JUNCTION BOX
*CE LUMINAIRE DOIT ÊTRE MONTÉ OU SUPPORTÉ DANS UNE BOÎTE
DE JONCTION*

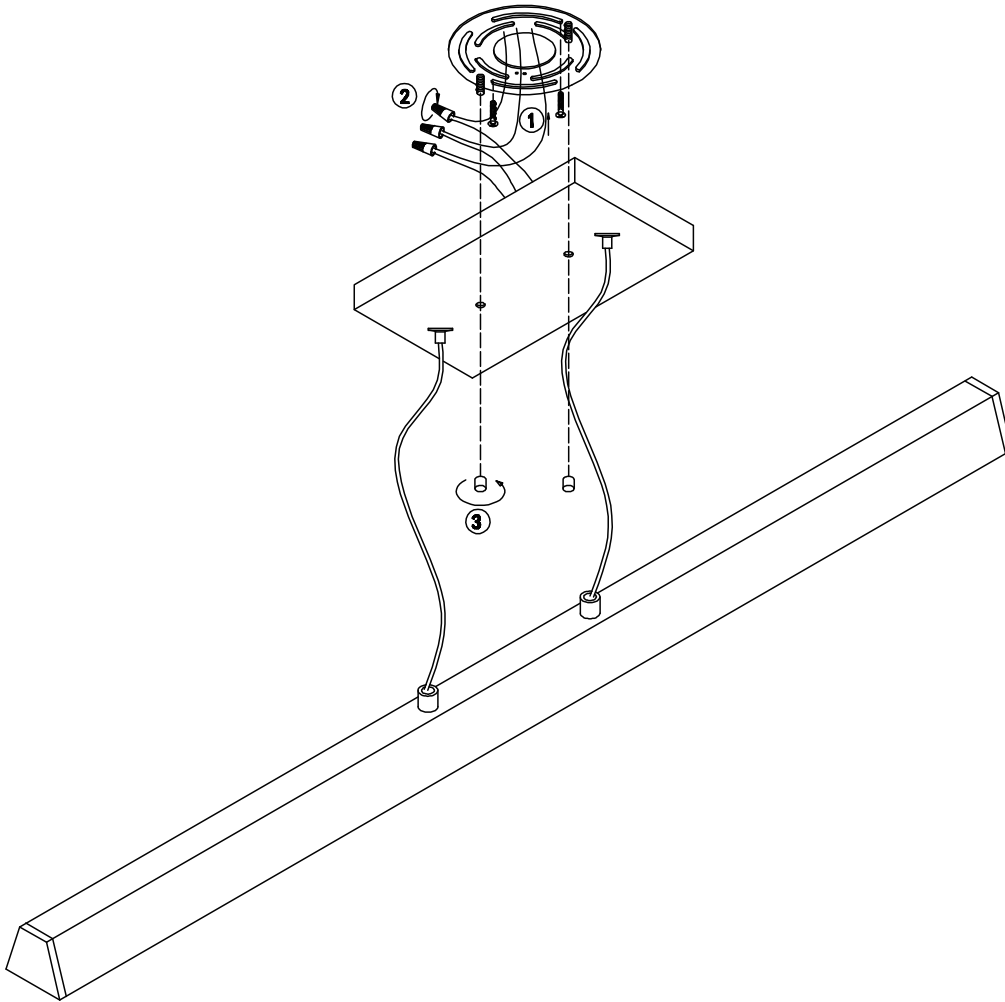

- Ensure main supply is switched off.
- Fit mounting bracket onto mounting surface with screws (1).
- Connect wires (4) according to color (White to White, Black to Black). Connect all earth lug together onto the crossbar with green screw to tight.
- Fit canopy onto mounting bracket with finials (3).
- Reconnect power.
- Light source : AC LED 2*16W, dimmable, 3CCT: 3000K, 4000K, 5000K, CRI90.